

SPICE thermal model

PSMN2R0-25YLD

Symbol	Parameter	Conditions	Min	Typ	Max	Unit
$R_{th(j-mb)}$	thermal resistance from junction to mounting base		-	-	1.43	K/W

C_{th1}	3.218E-05 F
C_{th2}	1.930E-04 F
C_{th3}	2.308E-04 F
C_{th4}	2.046E-03 F
C_{th5}	2.359E-03 F
C_{th6}	8.892E-03 F
C_{th7}	1.080E-01 F
R_{th1}	2.472E-03 Ω
R_{th2}	5.082E-03 Ω
R_{th3}	3.737E-02 Ω
R_{th4}	4.843E-02 Ω
R_{th5}	2.843E-01 Ω
R_{th6}	9.461E-01 Ω
R_{th7}	1.088E-01 Ω

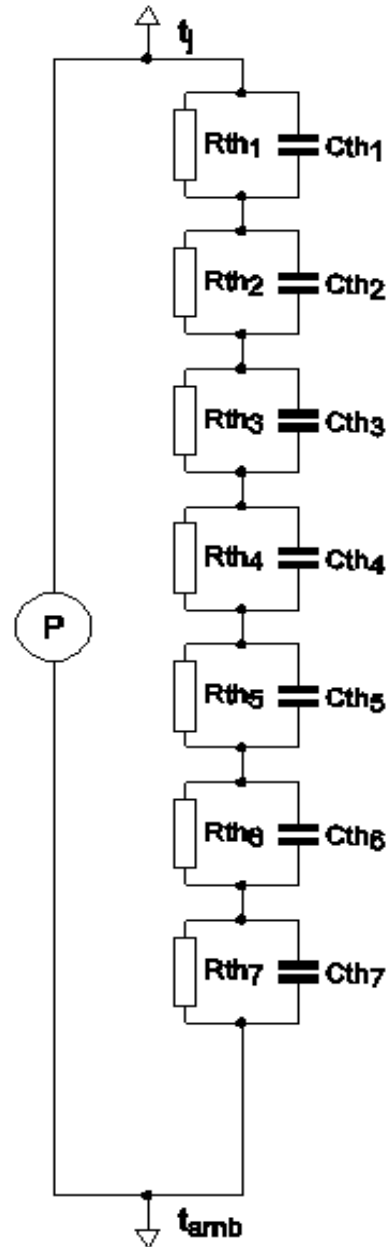

Part: PSMN2R0-25YLD
 Date: 21/3/2016
 Model Rth 1.43 K/W